

File: \\us01\proj\01\Draw\Projects\Jobs\Rem.Eng\Project_Files\PPG_Industries\Garfield Avenue\102 Design\CAD\DWG\Construction Drawings\Rev.1\C-03.dwg Layout_X-01.2 User: AmyKraemer Plotter: Jun 05, 2019 - 12:15pm Prof.s

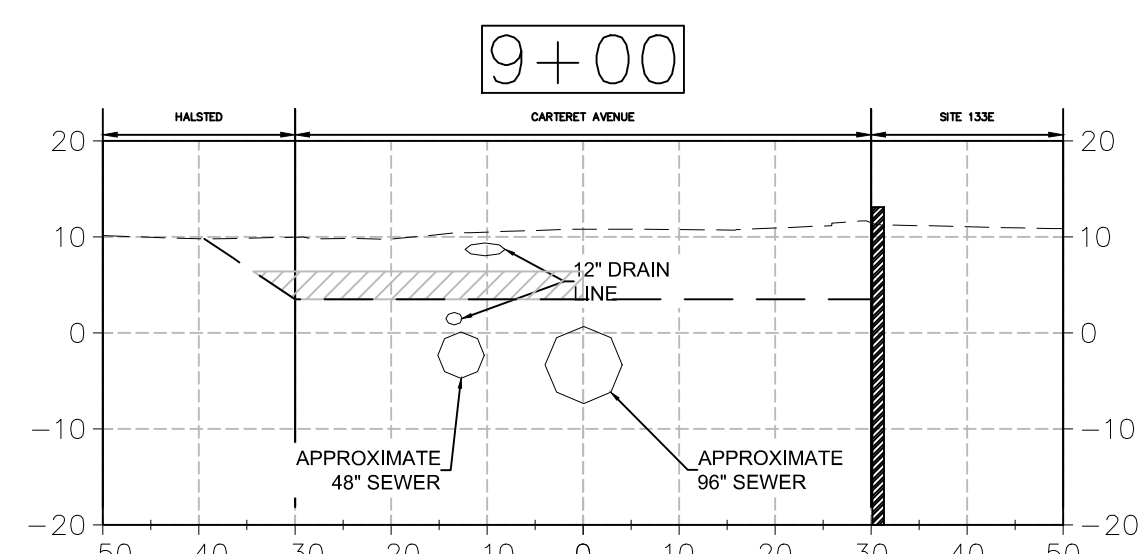
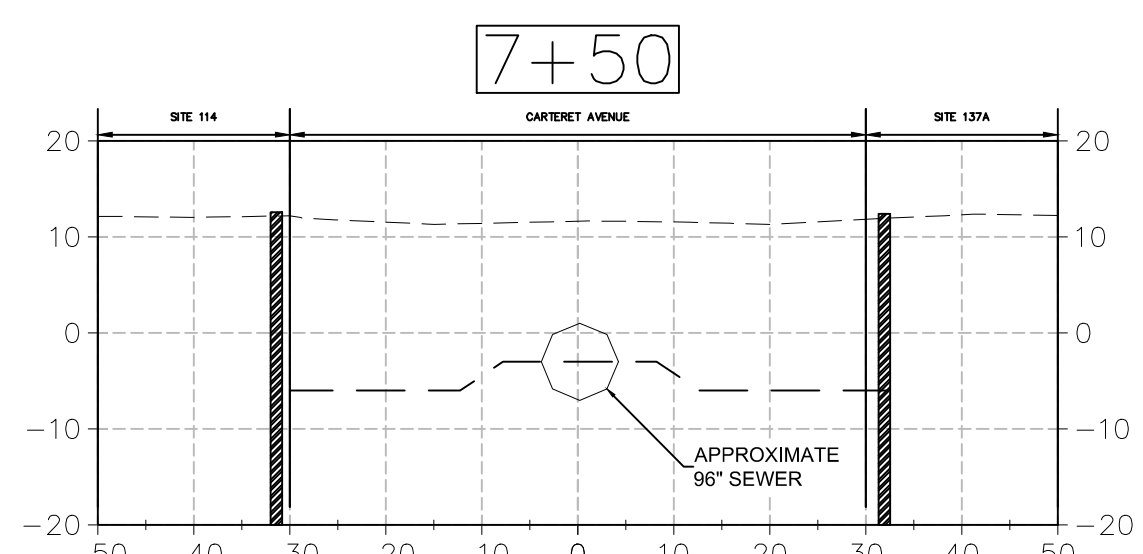
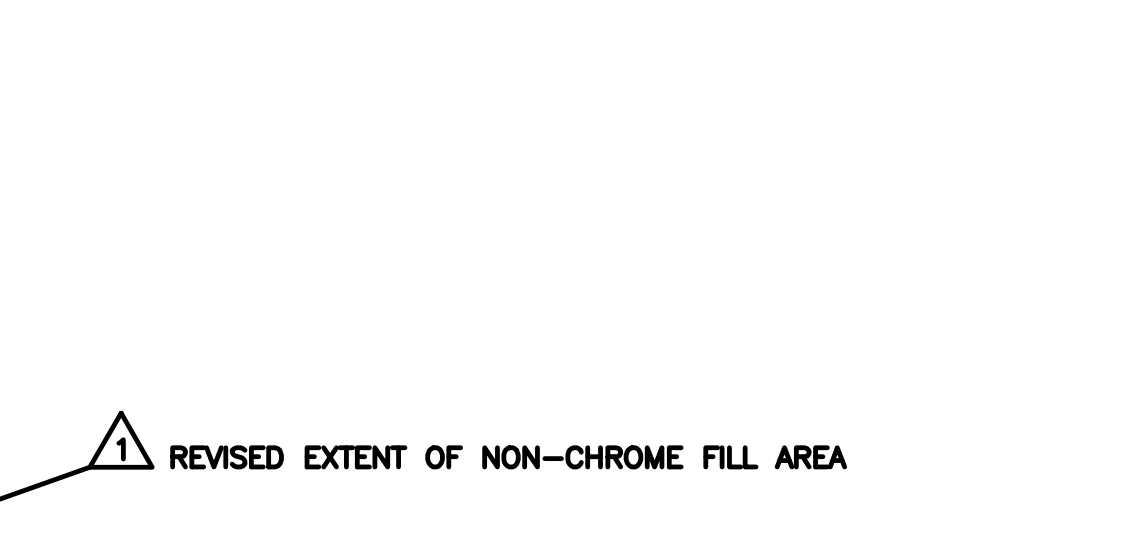
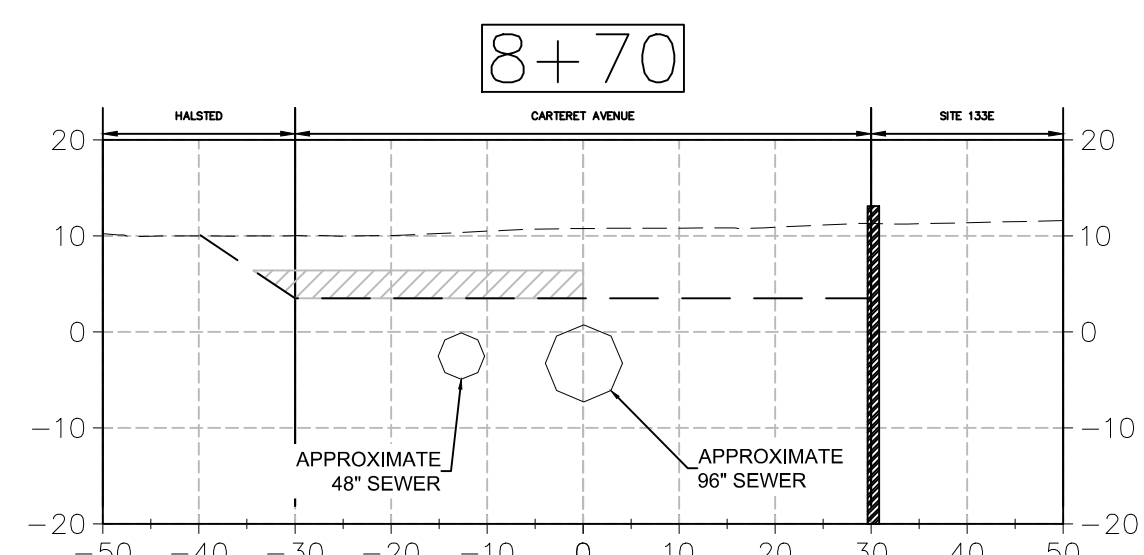
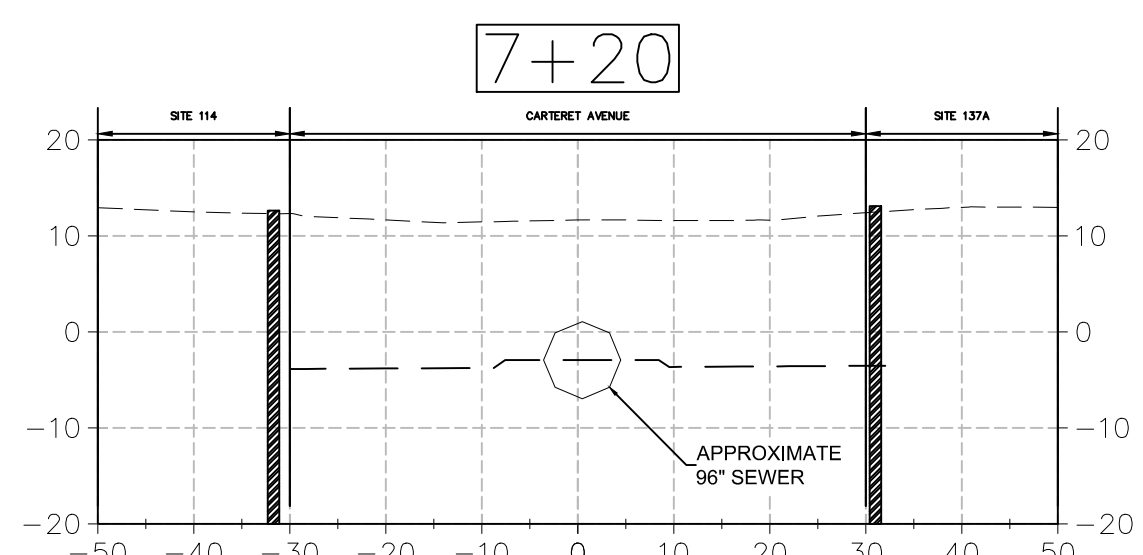
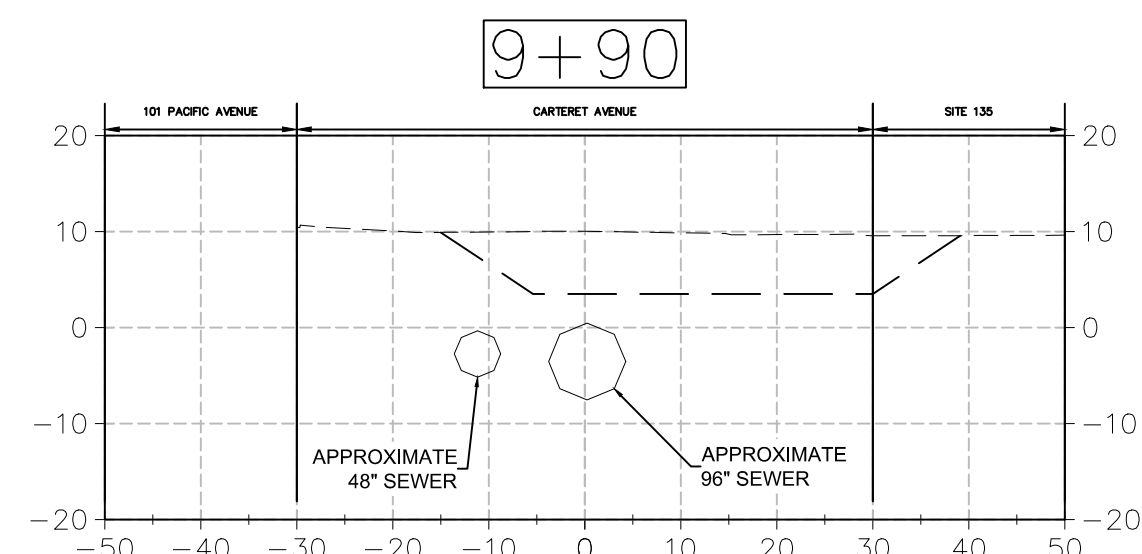
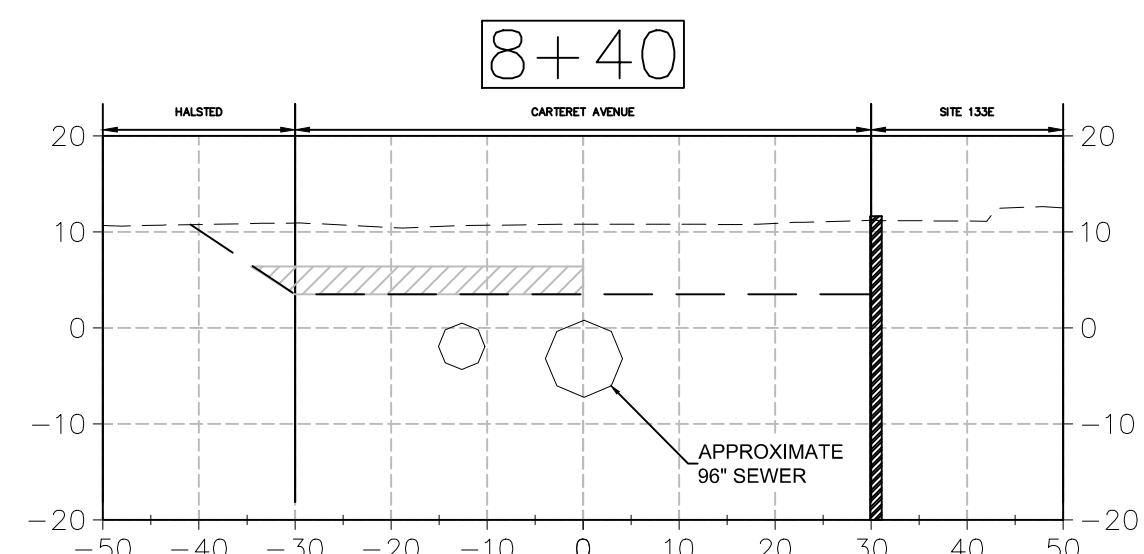
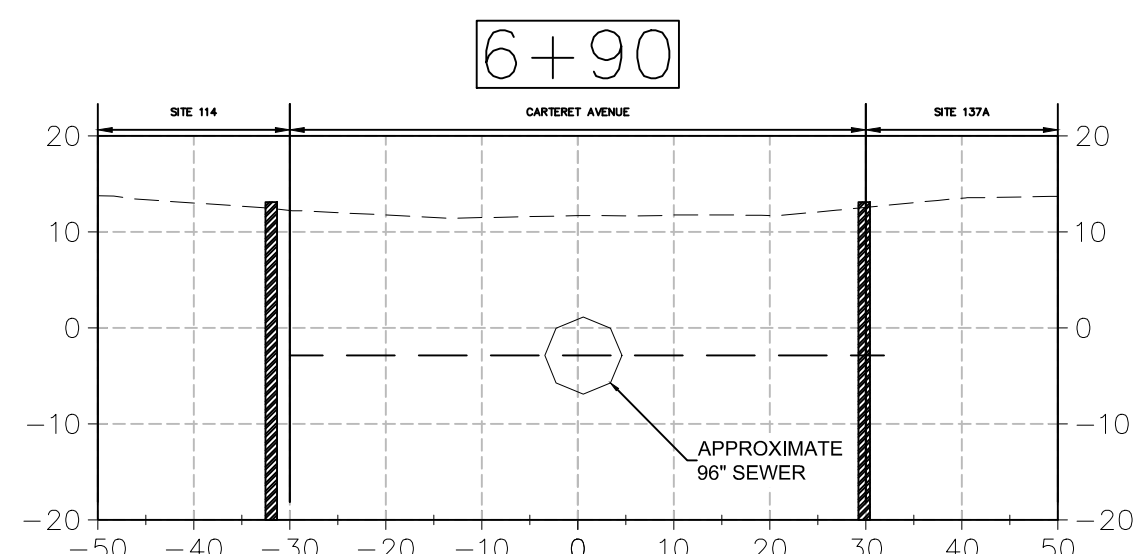
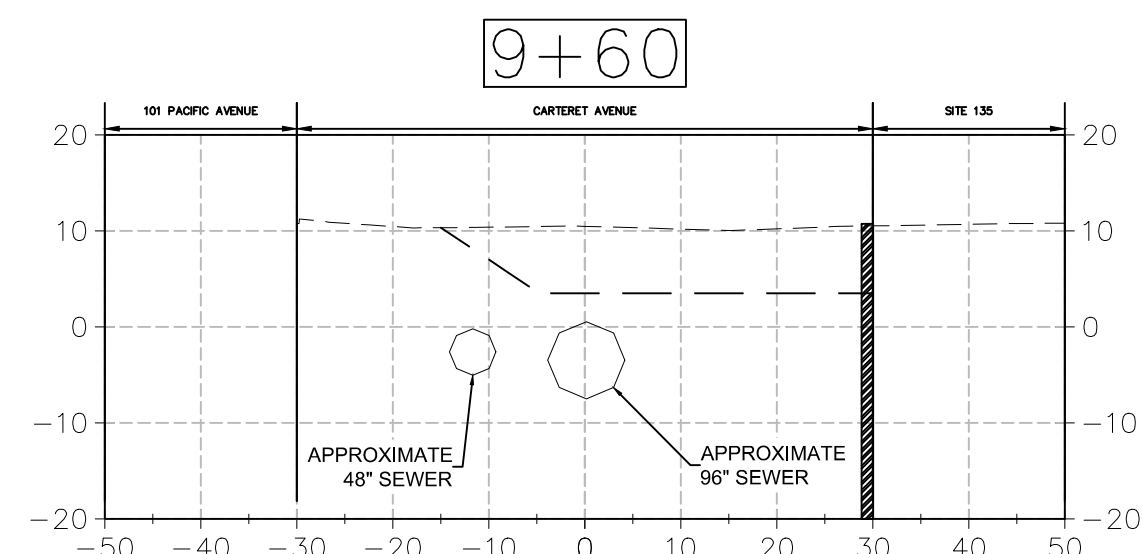
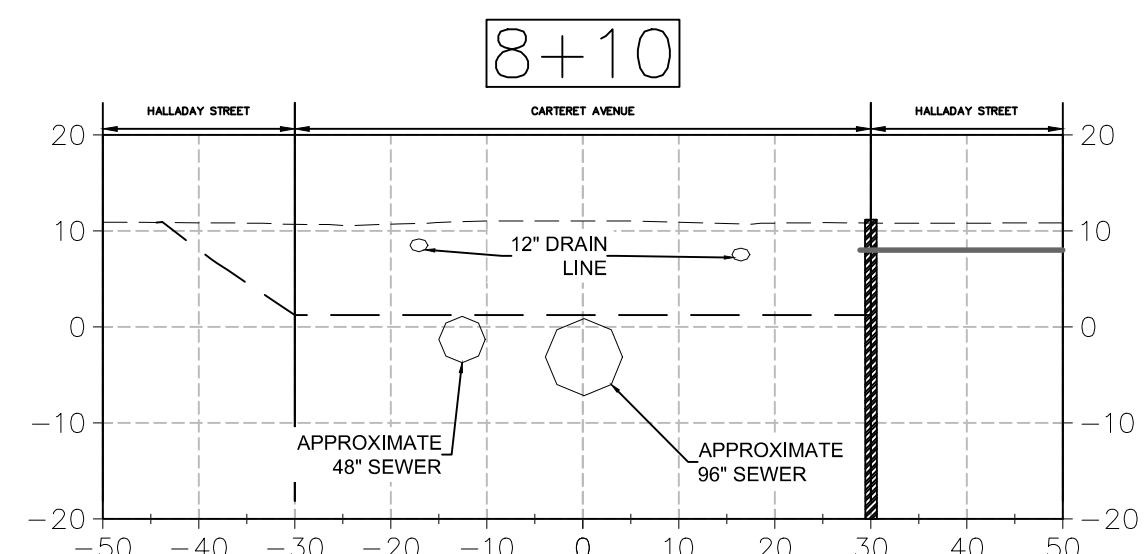
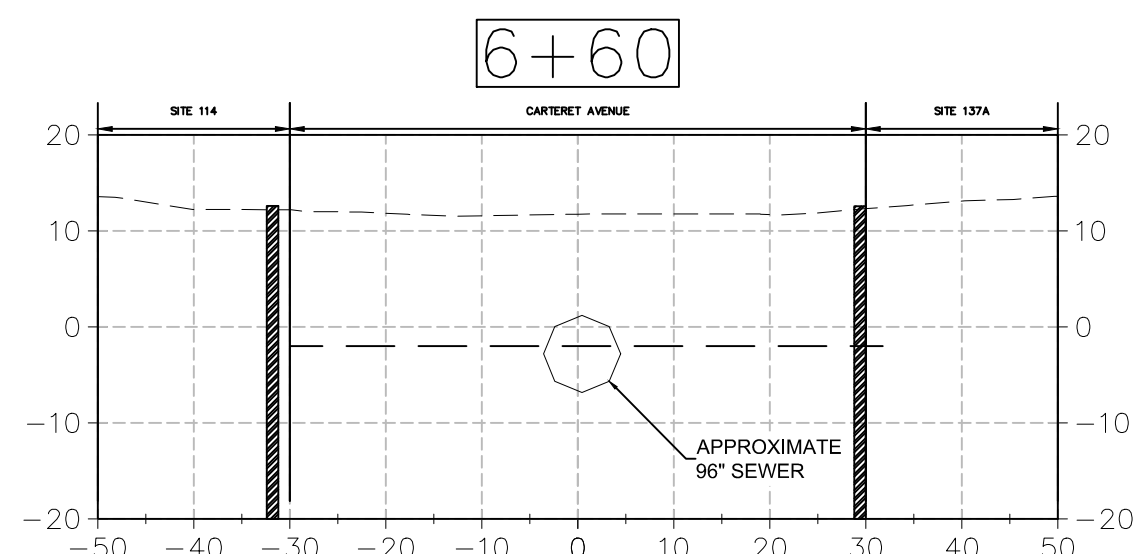
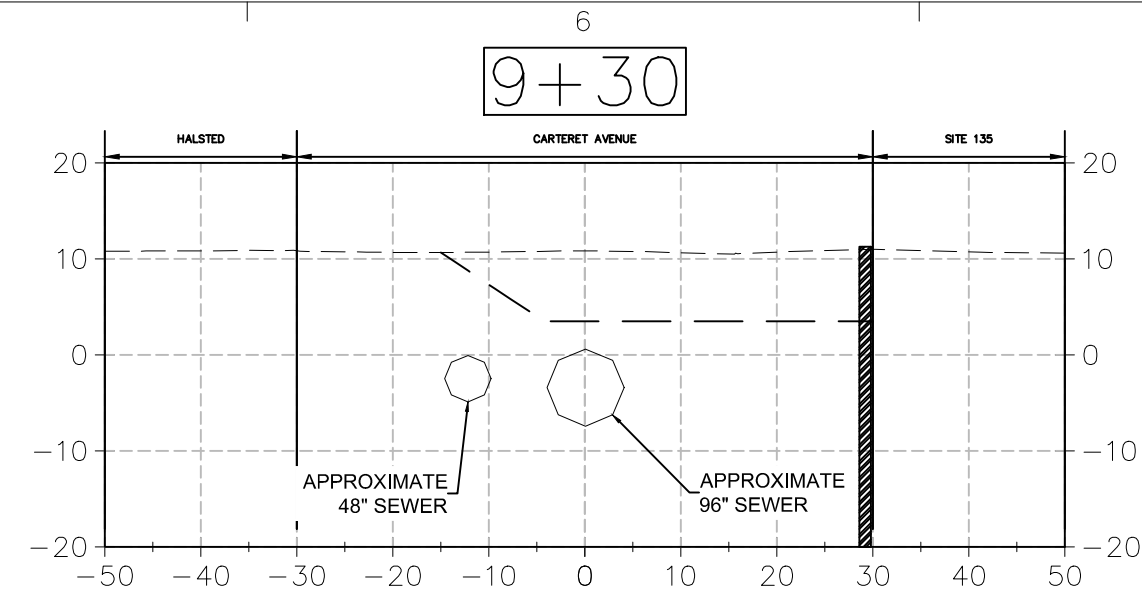
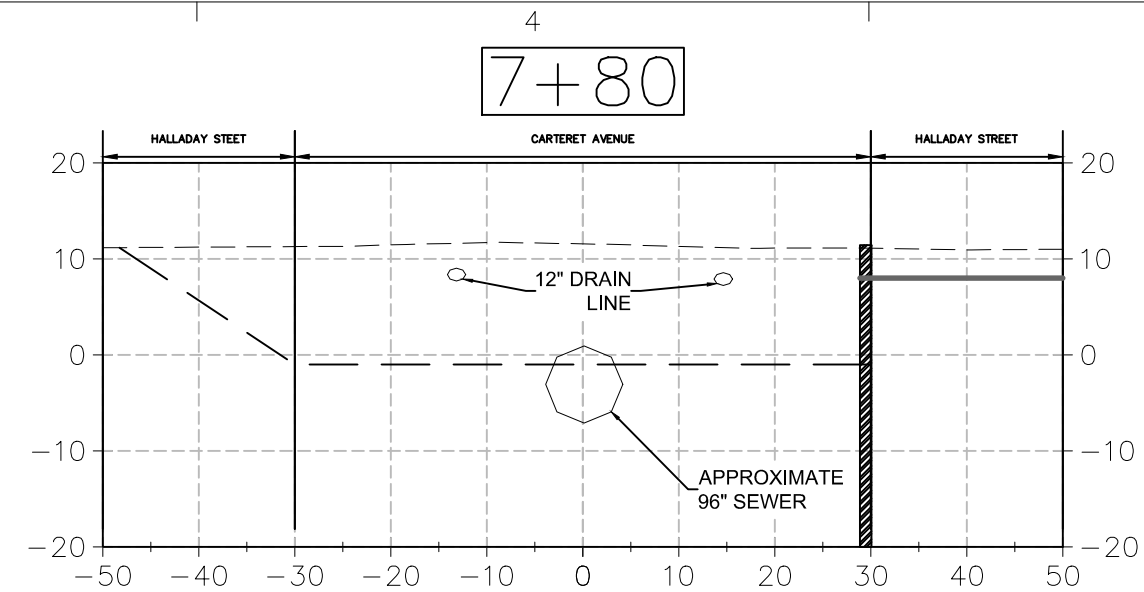
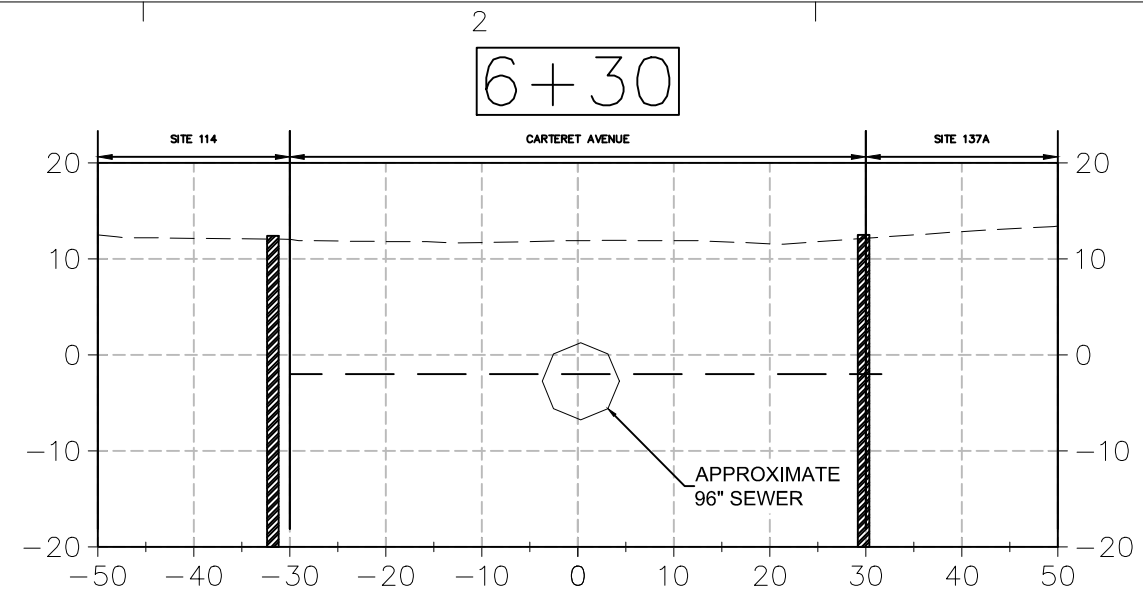

▲ REVISED EXTENT OF NON-CHROME FILL AREA

ISSUED FOR CONSTRUCTION

7							
6							
5							
4							
3							
2							
1	JJA	06/05/2019	REVISED EXTENT OF NON-CHROME FILL AREA				
0	ASK	04/24/2019	ISSUED FOR CONSTRUCTION				
NO	DRWN	DATE	REVISION	CHKD	DATE	APPVD	DATE

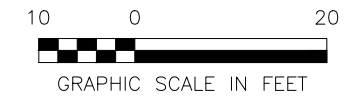

AECOM
30 Knightsbridge Road, Suite 520
Piscataway, NJ 08854
www.aecom.com

PPG
GARFIELD AVENUE GROUP OF SITES
JERSEY CITY, NEW JERSEY

PROJ. NUMBER: 60580814 DATE: 06/05/2019

EXCAVATION CROSS SECTIONS

CARTERET AVENUE
REMEDATION DESIGN DRAWINGS

DRAWING NUMBER:
X-01.2

SHEET NUMBER:
1 OF 2

REVISION
1